

JESI 4S

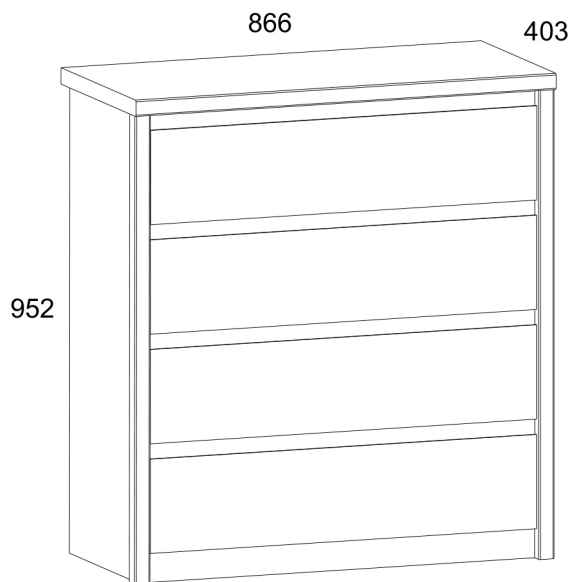

Navodila za uporabo.

Priporočljivo je, da ob nakupu razpakiranega izdelka v trgovini preverite njegovo kakovost in popolnost. Izdelek je treba sestaviti tako, kot je opisano v tem priročniku. Medtem ko je izdelek v uporabi, je treba občasno zategniti ohlapne vijačne povezave. Če je treba premikati predmete po stanovanju, morate pred premikanjem izdelek popolnoma sprostiti z bremena (ležišča). Da bi preprečili poškodbe obstoječih nosilcev, je treba izdelek pred premikanjem dvigniti. Pohištvo ne sme biti izpostavljeno stiku z vodo. Brisanje prahu iz izdelka je treba opraviti z rahlo vlažno mehko krpo. Da bi preprečili deformacijo delov in spremembo barve izdelkov, pohištva ne nameščajte na neposredno sončno svetlobo.

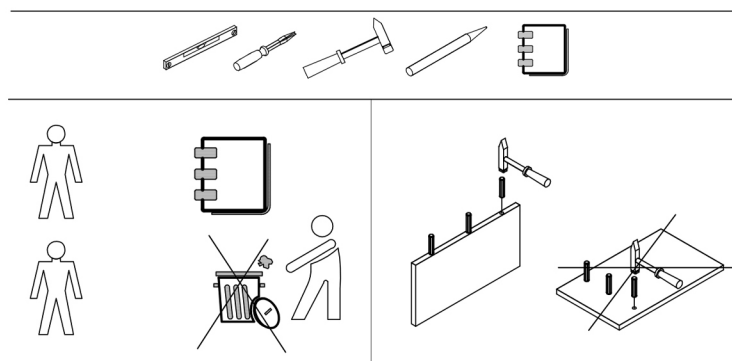











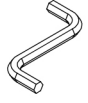

Medtem ko je izdelek v uporabi, je **PREPOVEDANO**:

- nameščati pohištvo v bližini grelnih naprav, blizu surovih sten in v prostorih z relativno vlažnostjo nad 70 %;
- segrevati elementov pohištva na temperaturo, višjo od 40 C;
- med sestavljanjem in uporabo kompleta izdelkov stopati na vodoravne ščite in okna;
- uporabljati kemičnih čistil za čiščenje pohištva;

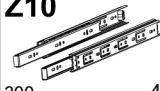
Garancija proizvajalca.

1. Garancijski rok za uporabo izdelka - 24 mesecev od datuma prodaje. V garancijskem roku proizvajalec zagotavlja popravilo ali zamenjavo izdelkov, če uporabnik ni kršil pravil uporabe.
2. Reklamacije mora potrošnik vložiti neposredno pri trgovski organizaciji, v kateri je bilo pohištvo kupljeno, pri čemer mora predložiti "Navodila za uporabo" in kopijo potrdila o prodaji.
3. Izdelek, bočna omara 3D2S, ki je del sklopa "JAZZ", izpolnjuje 2 zahteve standarda GOST 16371-2014, TR TS 025/2012.
4. Življenjska doba pohištva je 5 let.
5. Proizvajalec si pridržuje pravico do sprememb v zasnovi izdelka, ne da bi pri tem ogrozil njegove zahteve glede zasnove in uporabe.
6. Za sestavljanje izdelkov je priporočljivo pritegniti usposobljeno osebje. To je pomembno! Navodila shranite za primer ponovne montaže pohištva ali reklamacije. Pri uveljavljanju reklamacije uporabite zapis iz navodila.

Koda	Dimenzije				paket
11	866	403	32	1	3/3
41	800	60	16	2	3/3
105	916	394	32	1	1/3
106	916	394	32	1	1/3
159*	796	184	16	1	2/3
166	796	184	16	3	1/3
176	320	100	16	4	1/3
177	320	100	16	4	1/3
187	742	100	16	4	1/3
261	800	70	16	3	3/3
262	800	60	16	2	3/3
313	772	325	2,5	4	3/3
363	881	826	2,5	1	1/3

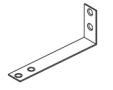
A1  24	A2  24	C1  8x35 44
R24  7x50 16	S5  16	G  1,5x26 30
I  1	L1  320 4	R102  3,5x16 10
Z10  300 4	R27  5,0x13 40	R3  3x20 40
B5  10x50 1	N1  4	Q  8
		U  1

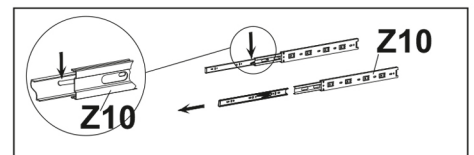
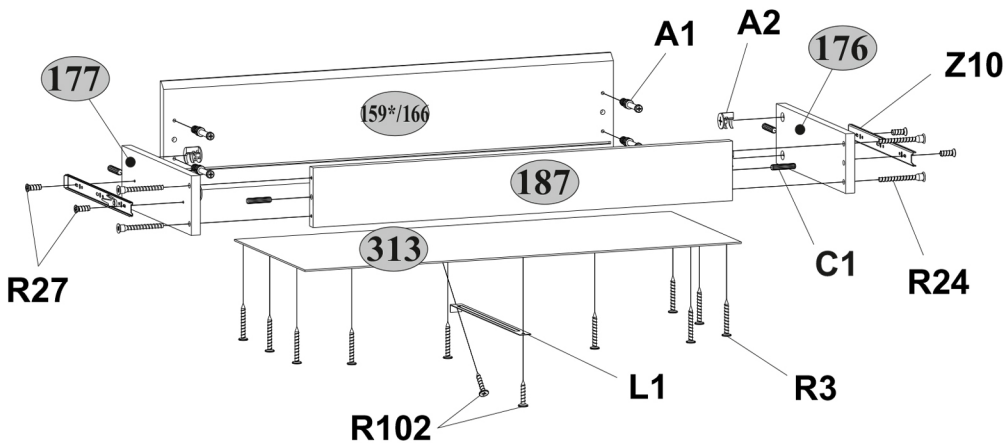
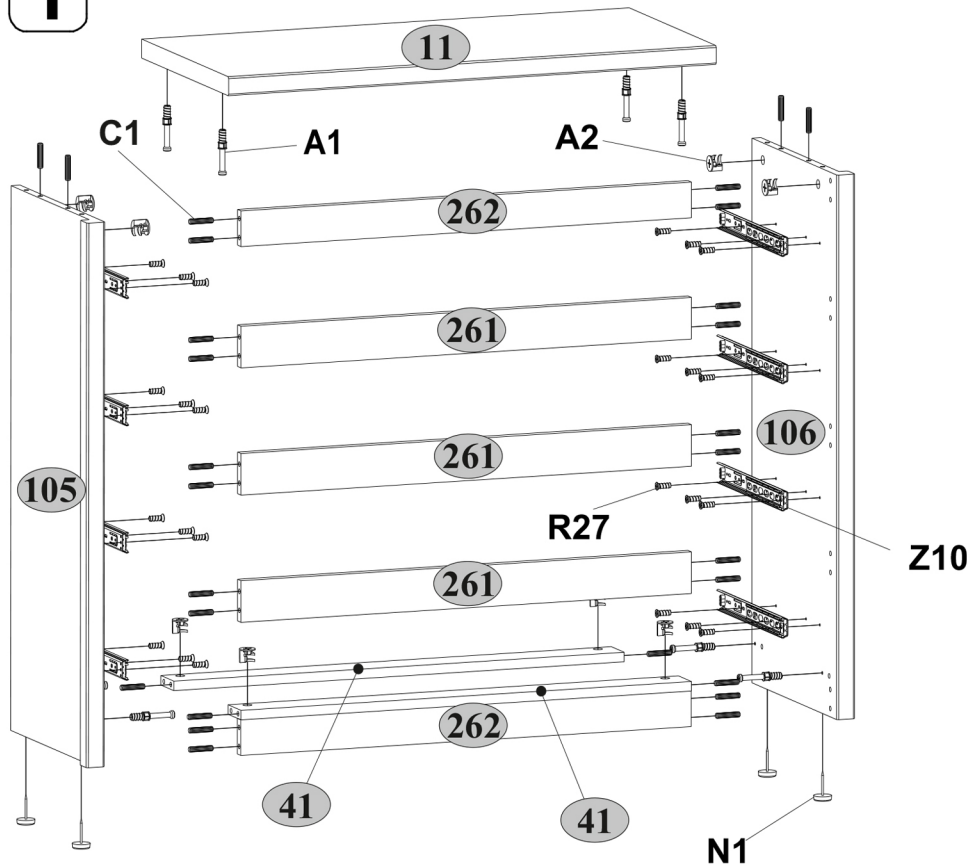

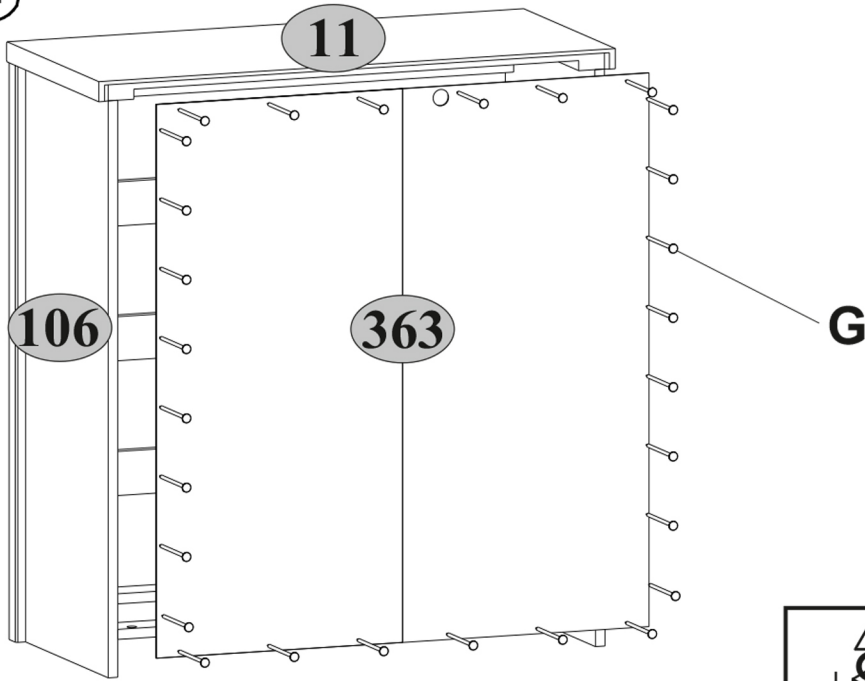

IV

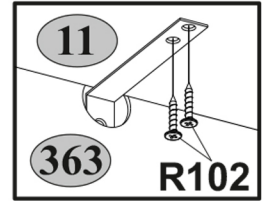
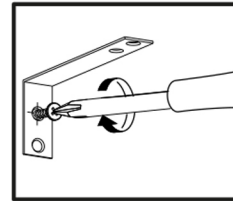
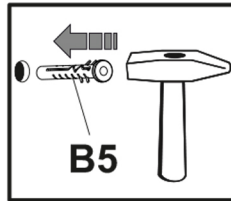
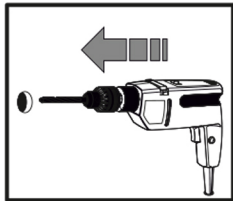
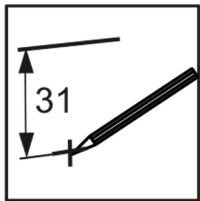
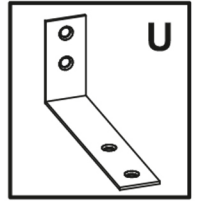
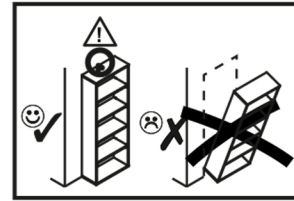

max.
5 kg

max.
5 kg

